

RoHS

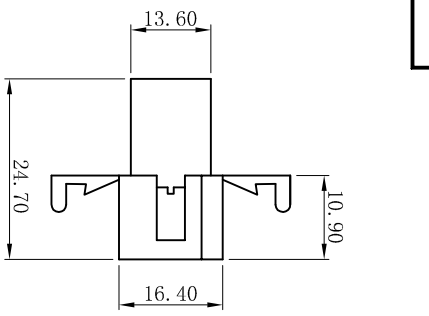

H5032-02P  
H5032NE-02P

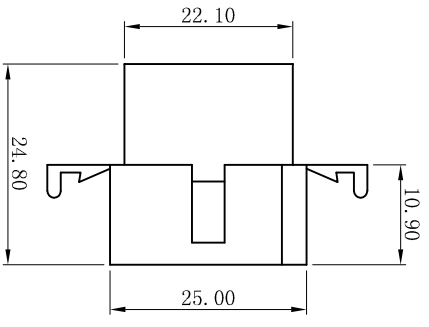
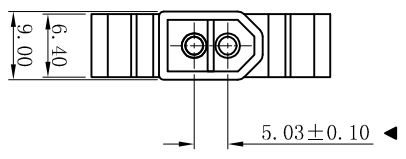

H5032-04P  
H5032NE-04P

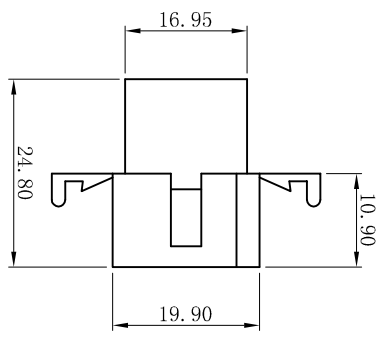
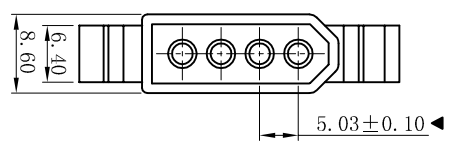

H5032-03P  
H5032NE-03P

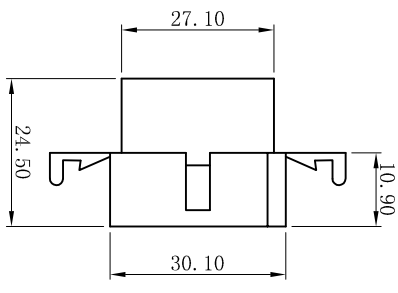
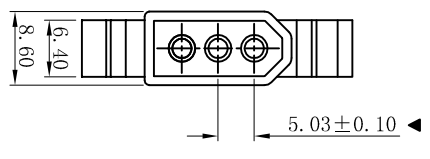

H5032-05P  
H5032NE-05P

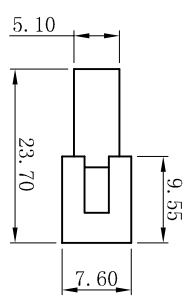
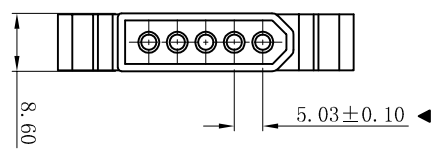

H5032-01P



- SPECIFICATIONS
- Voltage rating: 250V AC, DC
  - Current rating: 7A, AC, DC
  - Withstanding Voltage: 1500V AC/minute
  - Insulation resistance: 1000MΩ min
  - Temperature range: -25° C~+85° C
- HOUSING
- Part No. : H5032-1xNP
  - Poles : 01-05P
  - Housing Material : PA66 UL94V-2
  - The Dimension Marked “▼” Must Be Recorded

|            |  |            |  |        |  |  |  |                                    |  |  |  |
|------------|--|------------|--|--------|--|--|--|------------------------------------|--|--|--|
| 更新图面       |  | 2019-06-03 |  | 陈雄军    |  | 一般公差<br>GENERAL TOLERANCE:<br>0±0.30<br>.0±0.25<br>.000±0.20<br>ANGLE: ±1° |  | 投影法<br>Projection<br>单位 Unit<br>MM |  | 品名<br>(PART NAME)<br>5.03mm Female Housing<br>Connector Series |  |
| 修订图面       |  | 2015-11-04 |  | 陈雄军    |  | .000±0.05  |  | 审核/CHECK<br>陈雄军                    |  | 料号<br>(PART NO)<br>H5032-1xNP                                  |  |
| 变更图规格式内容   |  | 2013-12-27 |  | 陈雄军    |  | .000±0.05  |  | 批准/APPRO<br>胡进                     |  | 状态码<br>C   |  |
| 新版本        |  | 2011-05-24 |  | 陈雄军    |  | ANGLE: ±1°   |  | 日期/DATE<br>2019-06-03              |  |  |  |
| 说明         |  |            |  | 承认     |  |  |  |                                    |  |  |  |
| DESCRPTION |  |            |  | APPRO. |  |  |  |                                    |  |  |  |

XYDZ® 东莞市祥运连接器有限公司  
Dongguan XiangYun Connectors CO., Ltd

|   |   |   |   |   |   |   |   |   |    |
|---|---|---|---|---|---|---|---|---|----|
| 1 | 2 | 3 | 4 | 5 | 6 | 7 | 8 | 9 | 10 |
|---|---|---|---|---|---|---|---|---|----|