

ROHS HF

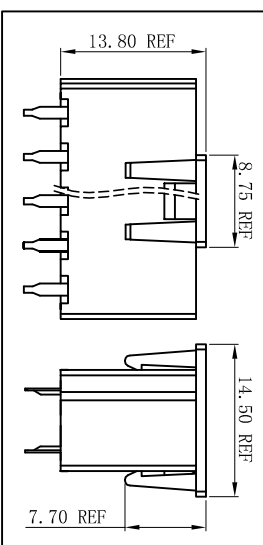

SHOWN WITH DISPOSABLE CAP
(FOR REMOVAL FROM TAPE & REEL PACKAGING)

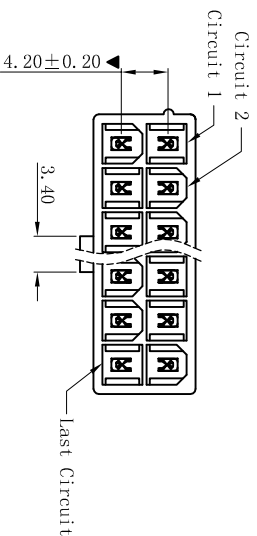
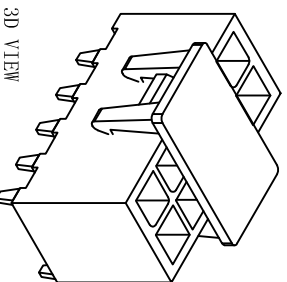
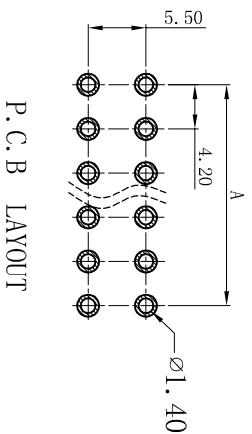
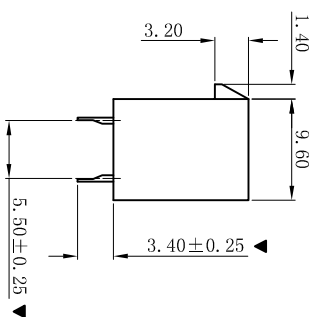
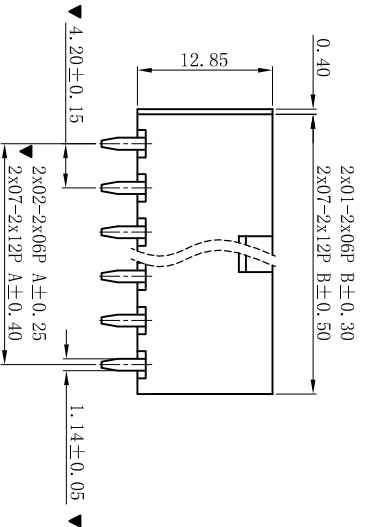

■ SPECIFICATIONS

- Voltage rating: 600V AC, DC
- Current rating: 7A, AC, DC
- Withstanding Voltage: 1500V AC/minute
- Insulation resistance: 1000MΩ min
- Temperature range: -25° C~+85° C
- Contact resistance: 20mΩ max

■ WAFER

- Part No. : W4202VT-2xNP-9T BK-HF-CAP
- Poles : 02-24P
- Housing Material: PA9T/LCP UL94V-0 Black, Halogen Free
- Pin Material: Brass
- Contact Area Plating: 100u" Matte Tin Plating in the soldertail area, 60u" Nickel underplating overall.

- Mates With: H4201 dual row receptacle
- The Dimension Marked "▼" Must Be Recorded

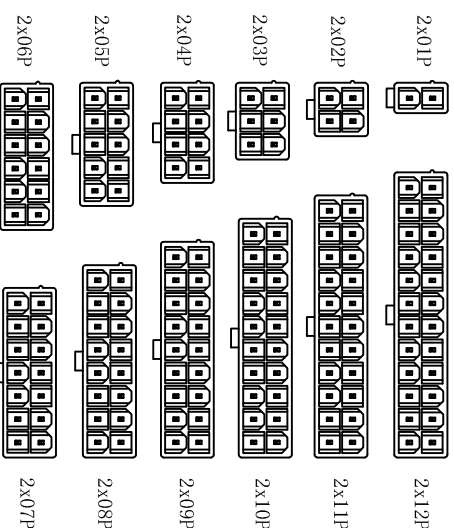

CIRCUIT SIZE LAYOUT

PART NO.	Dimensions(mm)	
	A	B
2x01	--	5.60
2x02	4.20	9.80
2x03	8.40	14.00
2x04	12.60	18.20
2x05	16.80	22.40
2x06	21.00	26.60
2x07	25.20	30.80
2x08	29.40	35.00
2x09	33.60	39.20
2x10	37.80	43.40
2x11	42.00	47.60
2x12	46.20	51.80

XYDZ® 东莞市祥运连接器有限公司
Dongguan XiangYun Connectors CO., Ltd

一般公差
GENERAL TOLERANCE:
0±0.30
-0±0.25
.00±0.20
.000±0.05
ANGLE: ±1°

更新图面
2019-07-03
陈雄军
P21 Draw

修打版本
2015-11-04
陈雄军

变更图宽格式内容
2013-12-27
陈雄军

新版本
2011-05-24
陈雄军

说明
2019-07-03
胡进
APPRO.

版次
REV.
1

投影法 Projection	品名 (PART NAME)	料号 (PART NO)	状态码
第一角 1:1	Molex 4.20mm 180° 空芯 Wafer Connector Series	W4202VT-2xNP-9T BK-HF-CAP	C
单位 Unit	MM		
比例/Scale	1:1		
大小/Size	A4		
页码/Sheet	1/1		
版本/Rev	D		