

ROHS

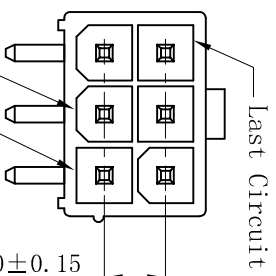

普通孔位

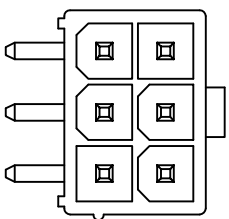

2方4圆孔位 (PCI)

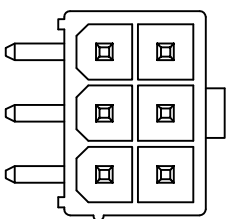

3方3圆孔位 (3F3Y)

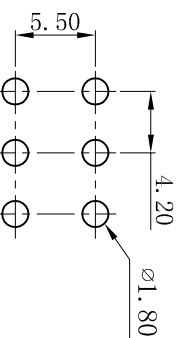
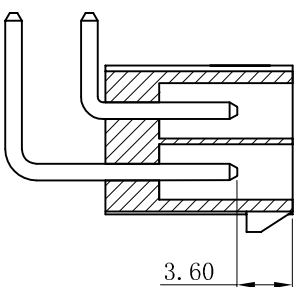
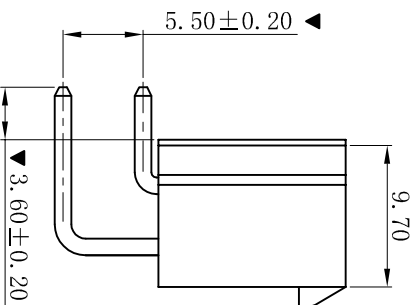
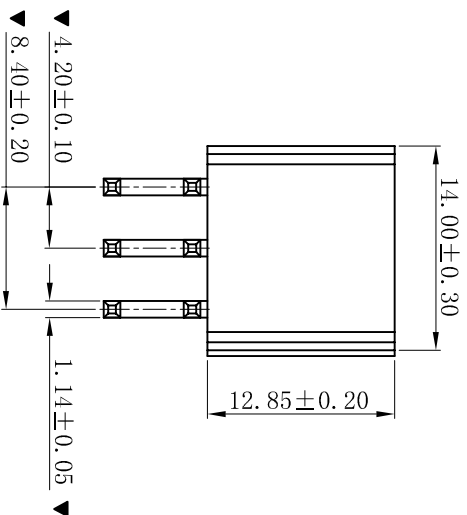

P.C.B LAYOUT

■ SPECIFICATIONS

- Voltage rating: 600V AC, DC
 - Current rating: 7A, AC, DC
 - Withstanding Voltage: 1500V AC/minute
 - Insulation resistance: 1000MΩ min
 - Temperature range: -25° C~+85° C
 - Contact resistance: 20mΩ max
- WAFER
- Part No.: W4202R-2x03P-X-XXX
 - Poles: 06P
 - Housing Material: PA66 UL94V-2 or UL94V-0
 - Pin Material: Brass
 - Contact Area Plating: Tin-Plated or Gold-Flash
 - The Dimension Marked “▼” Must Be Recorded

W4202R-2x03P-X-X X X

- None:普通孔位
 - PCI:2方4圆孔位
 - 3F3Y:3方3圆孔位
 - HSG Material/COLOR
 - None:PA66-V2 Natural
 - BK:PA66-V2 Black
 - V0:PA66-V0 Natural
 - V0BK:PA66-V0 Black
 - LP:LCP-V0 Natural
 - LPBK:LCP-V0 Black
 - 9T:PA9T-V0 Natural
 - 9T1BK:PA9T-V0 Black
- CONTACT FINISH
- None: Tin-Plated
 - SW: Matte Tin-Plated
 - G: Gold-Flash
 - G3: 3u" Gold
 - G10: 10u" Gold
 - G15: 15u" Gold
- X: 颜色参照对照表

颜色对照表

颜色	料号/编码	蓝色	蓝色	BL
本色	None	橙色		OE
黑色	BK	红色		RD
大红色	TR	黄色		YW
明红色	MR	绿色		GN
白色	WE	灰色		GY

XYDZ® 东莞市祥运连接器有限公司
Dongguan XiangYun Connectors CO., Ltd

一般公差 GENERAL TOLERANCE:	0±0.30 .0±0.25 .000±0.05
角度: ±1°	

Connectors

投影法
Projection

单位 Unit
MM

比例/Scale
1:1

大小/Size
A4

页码/Sheet
1/1

版本/Rev
D

品名
(PART NAME)
Molex 4.20mm 90° Wafer
Connector Series

料号
(PART NO)
W4202R-2x03P-X-XXX

状态码
C

审核/CHKC
陈雄军

批准/APPRO
胡进

日期/DATE
2019-07-03

绘图/DR
陈雄军

日期/DATE
2019-07-03

更新图面
2019-07-03

修订版本
2015-11-04

变更图宽格式内容
2013-12-27

新版本
2011-05-24

说明
DESCRIPTION

承认
APPRO.

版次
REV.

1

2

3

4

5

6

7

8

9

10