

ROHS

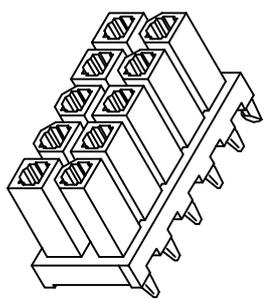
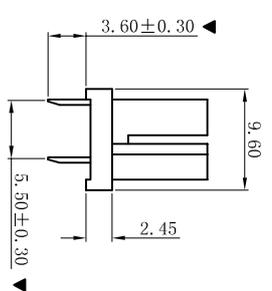
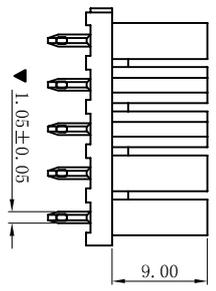
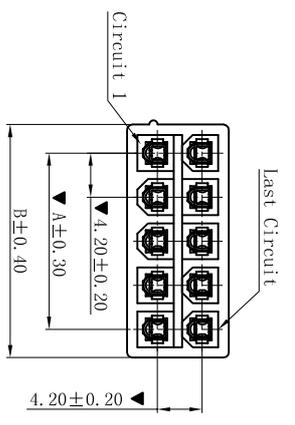

**SPECIFICATIONS**

- Voltage rating: 600V AC, DC
- Current rating: 7A, AC, DC
- Withstanding Voltage: 1500V AC/minute
- Insulation resistance: 1000MΩ min
- Temperature range: -25° C ~ +85° C
- Contact resistance: 20mΩ max

**WAFER**

- Part No.: W4201VT-2xNP-XX
- Poles : 02-24P
- Housing Material: PA66 UL94V-0 or UL94V-2
- Pin Material: Phosphor Bronze
- Contact Area: Selective Gold or Matte Tin Plating Thickness Min;
- Soldering Area: Matte Tin 100u" Plating Thickness Min.
- Under Plating: Nickel Plating 50u"
- The Dimension Marked "▼" Must Be Recorded

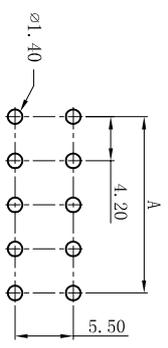

PCB LAYOUT: Component Side  
Recommended PCB Thickness 1.78MMX

**W4201VT-2xNP-XX**

HSG Material / COLOR  
None: PA66-V0 Natural  
V0BK: PA66-V0 Black  
V2: PA66-V2 Natural  
V2BK: PA66-V2 Black  
LP: LCP-V0 Natural  
LPBK: LCP-V0 Black  
9T: PA9T-V0 Natural  
9TBK: PA9T-V0 Black  
46: PA46-V0 Natural  
46BK: PA46-V0 Black

CONTACT FINISH  
None: Tin-plated  
SW: Matte Tin-Plated  
G: Gold-Flash  
G3: 3u" Gold  
G10: 10u" Gold  
G15: 15u" Gold  
G30: 30u" Gold

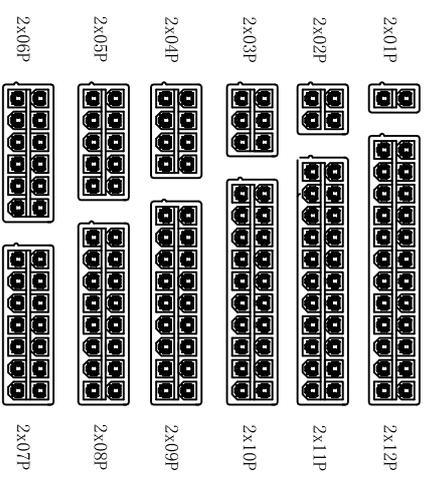

PART NO.	Dimensions (mm)	
	A	B
2x01	/	5.40
2x02	4.20	9.60
2x03	8.40	13.80
2x04	12.60	18.00
2x05	16.80	22.20
2x06	21.00	26.40
2x07	25.20	30.60
2x08	29.40	34.80
2x09	33.60	39.00
2x10	37.80	43.20
2x11	42.00	47.40
2x12	46.20	51.60

**XYDZ® 东莞市祥运连接器有限公司**  
Dongguan XiangYun Connectors CO., Ltd

D	更新图面	2019-07-03	陈雄军	一般公差 GENERAL TOLERANCE:	0±0.30 .0±0.25 .000±0.05
C	修订版本	2015-11-04	陈雄军	绘图/DR	陈雄军
B	变更图宽格式内容	2013-12-27	陈雄军	审核/CHECK	胡进
A	新版本	2011-05-24	陈雄军	批准/APPRO	胡进
H	版次 RRV.	说明 DESCRIPTION	日期 DATE	承认 APPRO.	日期/DATE

投影法 Projection	品名 (PART NAME)	料号 (PART NO)	状态码
MM	Mollex 4.20mm 180° 公座 Wafer Connector Series	W4201VT-2xNP-XX	C
单位 Unit	大小/Size	页码/Sheet	
1:1	A4	1/1	
版本/Rev	D		

RoHS

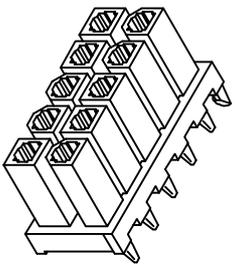

产品

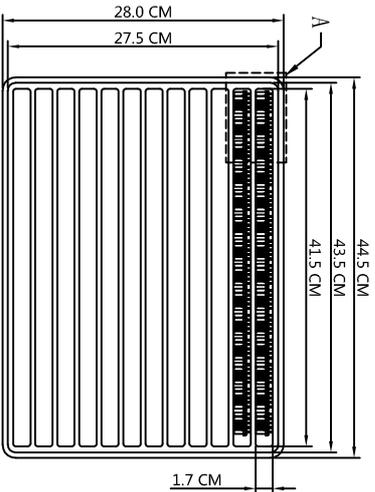

吸塑盘下盖(12格)

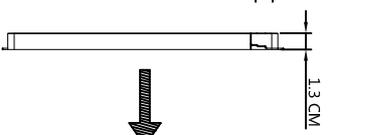

吸塑盘上盖

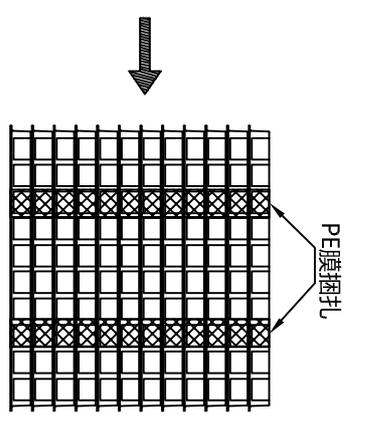

最上层盖—上盖

PIN/位	PCS/盘	层/箱	PCS/箱
2x1P	840	20	16800
2x2P	492	20	9840
2x3P	348	20	6960
2x4P	264	20	5280
2x5P	216	20	4320
2x6P	180	20	3600
2x7P	156	20	3120
2x8P	132	20	2640
2x9P	120	20	2400
2x10P	108	20	2160
2x11P	96	20	1920
2x12P	84	20	1680

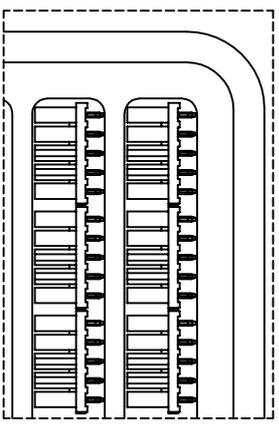

局部放大图A

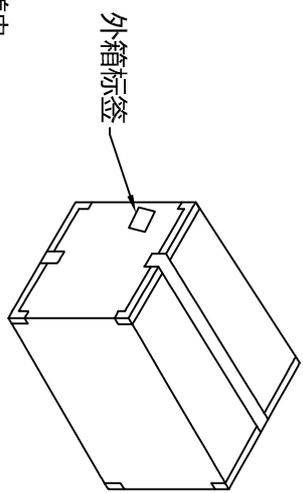

外箱标签

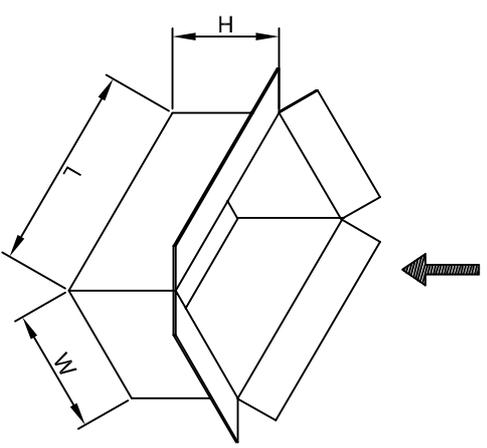

封箱(工字形)

外箱规格:  
45.0(L)x29.0(W)x25.0(H)CM

包装说明:  
步骤1: 将产品按要求整齐摆放入吸塑盘下盖内。  
在层叠起来方向需一致。  
步骤2: 按一箱层叠20层叠起来,最上层盖—上盖。  
然后用PE膜扎住为一箱,放入纸箱,封箱,贴外箱标签。  
注: 不满一箱时, 需以填充物填充, 不可有晃动。

Pin/位	PCS/盘	层/箱	PCS/箱
2x1P	840	20	16800
2x2P	492	20	9840
2x3P	348	20	6960
2x4P	264	20	5280
2x5P	216	20	4320
2x6P	180	20	3600
2x7P	156	20	3120
2x8P	132	20	2640
2x9P	120	20	2400
2x10P	108	20	2160
2x11P	96	20	1920
2x12P	84	20	1680

XYDZ® 东莞市祥运连接器有限公司 Dongguan XiangYun Connector s CO., Ltd		投影法 Connector s	
一般公差 GENERAL TOLERANCE: 0±0.50 .0±0.40 .00±0.30 .000±0.10 ANGLE: ±1°		单位 Unit MM	
绘图/DR 审核/CHECK 批准/APPRO		陈雄军 胡进	
日期/DATE		2019-06-15	
版次 REV.		A	
说明 DESCRIPTION		新版本	

品名 (PART NAME)		料号 (PART NO)		状态码	
Molex4.20mm 2xNP 180° 公座 Packaging Specification		W4201VT-2xNP		C	
日期/DATE		2019-06-15		承认 APPRO.	
日期/DATE		2019-06-15		承认 APPRO.	