

RoHS

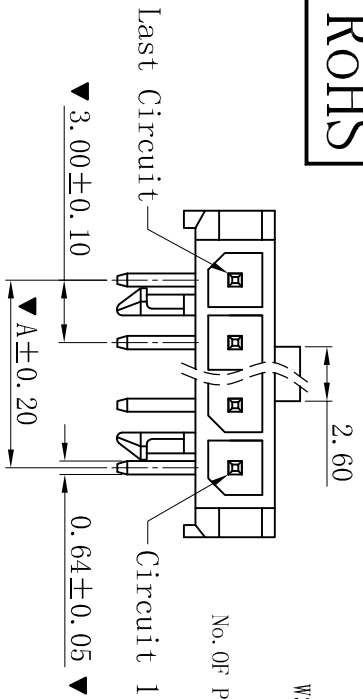

W3045R-1xNP-X
No. Of POSITION

REMOVED OMITTED CODE DESCRIPTION
 K01: 1th POSITION OMITTED
 K02: 2th POSITION OMITTED
 K03: 3th POSITION OMITTED
 Q23P: 2th & 3th POSITION OMITTED
 Q25P: 2th & 5th POSITION OMITTED

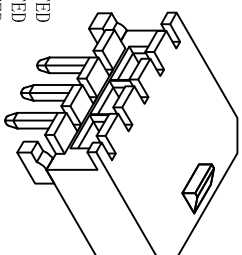

SPECIFICATIONS

- Voltage rating: 250V AC, DC
- Current rating: 5A, AC, DC
- Withstanding Voltage: 1500V AC/minute
- Insulation resistance: 1000MΩ min
- Temperature range: -25° C~+85° C
- Contact resistance: 20mΩ max

WAFER

- Part No.: W3045R-1xNP-X
- Poles : 02-12P
- Housing Material: PA66 15%GF UL94V-0 Black
- Pin Material: Brass
- Contact Area Plating: Tin-Plated
- The Dimension Marked "▼" Must Be Recorded

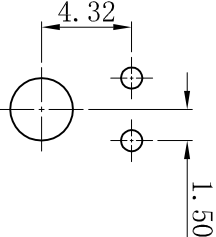
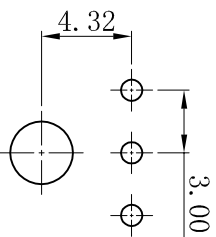
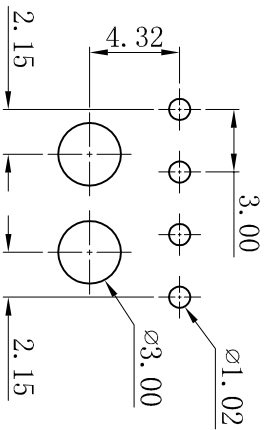
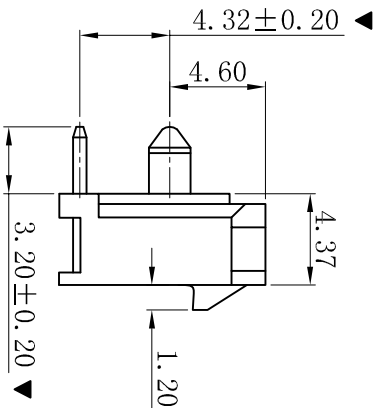
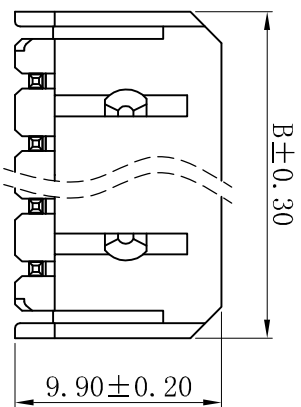

P. C. B. LAYOUT 04P-12P

PCB. LAYOUT: 03P

PCB. LAYOUT: 02P

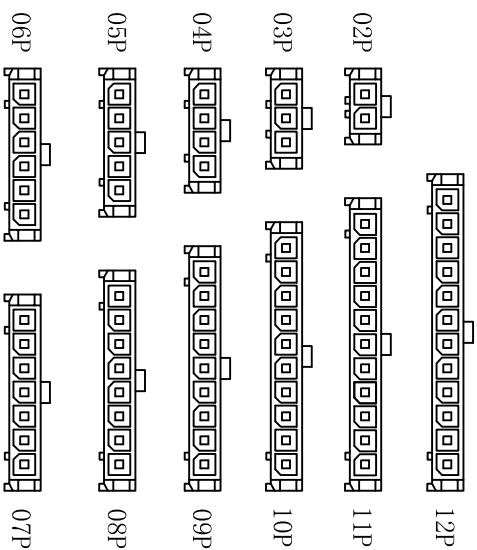

CIRCUIT SIZE LAYOUT

Poles	Dimensions (mm)	
	A	B
02	3.00	9.65
03	6.00	12.65
04	9.00	15.65
05	12.00	18.65
06	15.00	21.65
07	18.00	24.65
08	21.00	27.65
09	24.00	30.65
10	27.00	33.65
11	30.00	36.65
12	33.00	39.65

XYDZ® 东莞市祥运连接器有限公司
 Dongguan XiangYun Connectors CO., Ltd

一般公差 GENERAL TOLERANCE:	0±0.30 .0±0.25 .00±0.20 .000±0.05
ANGLE: ±1°	

绘图/DR	陈雄军
审核/CHECK	陈雄军
批准/APPRO	胡进

投影法 Projection	第一角
单位 Unit	MM
比例/Scale	1:1
大小/Size	A4
页码/Sheet	1/1
版本/Rev	D

更新图面	2019-06-03	陈雄军
修打版本	2015-11-04	陈雄军
变更图宽格式内容	2013-12-27	陈雄军
新版本	2011-05-24	陈雄军

品名 (PART NAME)	Molex 3.0mm 90° Wafer Connector Series
料号 (PART NO)	W3045R-1xNP-X

版次 REV.	1	说明 DESCRIPTION	日期 DATE	承认 APPRO.
------------	---	-------------------	------------	--------------

日期 DATE	2019-06-03	承认 APPRO.	胡进
------------	------------	--------------	----

状态码	C
-----	---