

RoHS

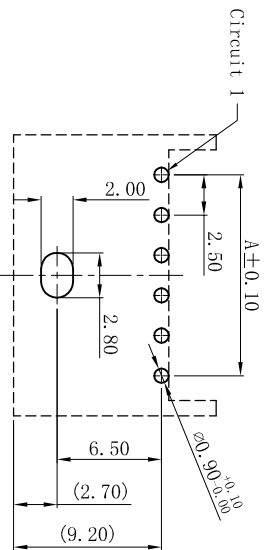
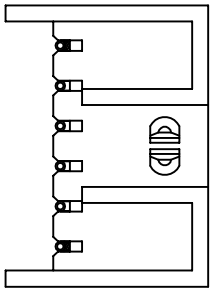
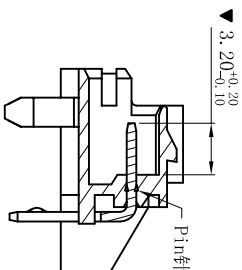
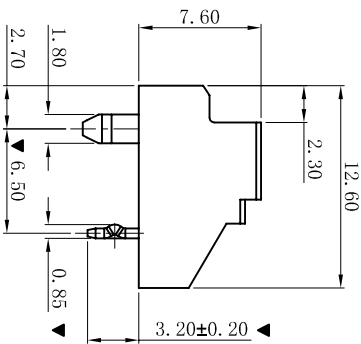
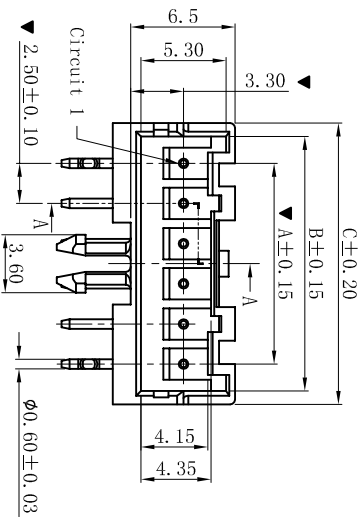
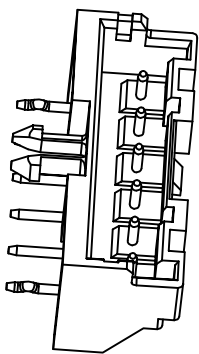
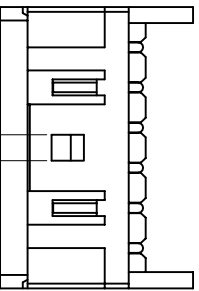

RECOMMENDED P. C. B LAYOUT T=1.60mm
(TOLERANCE: ±0.05mm)

- Specifications:
- Voltage rating: 250V AC / DC
 - Current rating: 3A AC / DC
 - Withstanding voltage: 1000V AC/minute
 - Temperature range: -40°C +105°C
 - Insulation resistance: ≥1000MΩ
 - Contact resistance: ≤10mΩ
 - After environmental testing: ≤20mΩ

■ WAFER

- Part No. : W2509RD-NP
- Poles : 02-15P
- Housing Material : PA66 UL94V-0
- Pin Material : Brass
- Contact Area Plating: Tin-Plated
- The Dimension Marked “▼” Must Be Recorded

Poles	Dimensions(mm)			Poles	Dimensions(mm)		
	A	B	C		A	B	C
02	2.50	5.85	7.50	09	20.00	23.35	25.00
03	5.00	8.35	10.00	10	22.50	25.85	27.50
04	7.50	10.85	12.50	11	25.00	28.35	30.00
05	10.00	13.35	15.00	12	27.50	30.85	32.50
06	12.50	15.85	17.50	13	30.00	33.35	35.00
07	15.00	18.35	20.00	14	32.50	35.85	37.50
08	17.50	20.85	22.50	15	35.00	38.35	40.00

XYDZ® 东莞市祥运连接器有限公司
Dongguan XiangYun Connector's CO.,Ltd

一般公差
GENERAL TOLERANCE:
0±0.30
.00±0.25
.000±0.20
.000±0.05
ANGLE: ±1°

Connectors

投影法
Projection



品名
(PART NAME)

XA 2.50mm 90° Wafer
Connector Series

单位 Unit

MM

比例/Scale

1:1

大小/Size

A4

页码/SHEET

1/2

版本/Rev

B

料号
(PART NO)

W2509RD-NP

日期/DATE

2019-06-03

状态码

C

更新图面	2019-06-03	2019-06-03	说明	新版本
版次	REV.	1	DESCRIPTION	1

审核/CHKC	陈雄军	日期/DATE	2017-12-21
批准/APPRO	胡进	日期/DATE	2019-06-03

绘图/DR	2019-06-03	日期/DATE	2019-06-03
承认	JEFF	日期/DATE	2019-06-03

RoHS

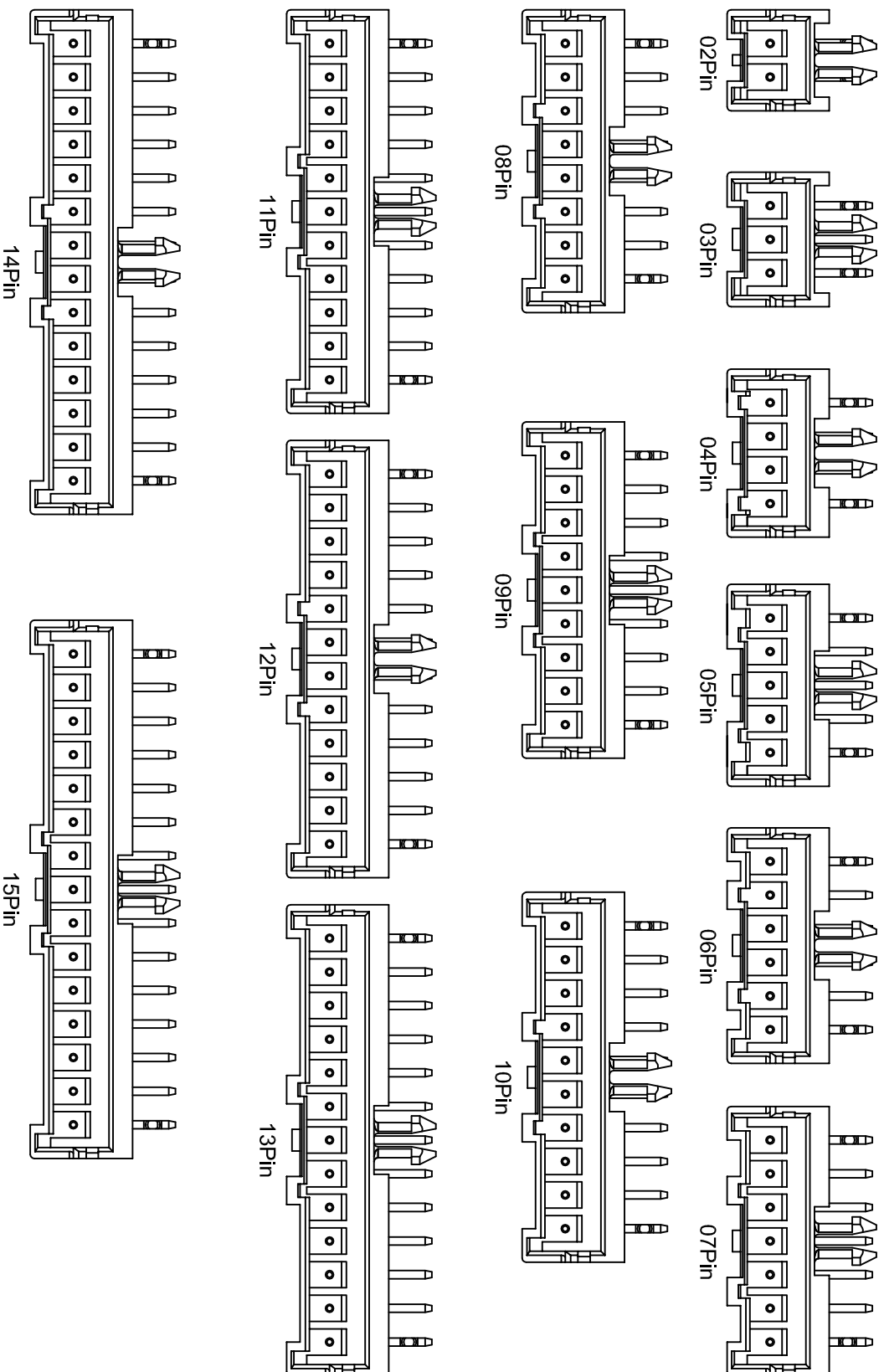

B	更新图面		2019-06-03	<i>PPZ, David</i>					
A	新版本		2017-12-21	Jeff					
H	版次	说明	日期	承认	日期/DATE	胡进	2019-06-03		
1	REV.	DESCRIPTION	DATE	APPRO.		版本/Rev	B		

<p>XYDZ® 东莞市祥运连接器有限公司 Dongguan XiangYun Connectors CO., Ltd</p>	
<p>一般公差 GENERAL TOLERANCE: 0±0.30 0±0.25 .00±0.20 .000±0.05 ANGLE: ±1°</p>	<p>投影法 Projection 单位 Unit MM 比例/Scale 1:1 大小/Size A4 页码/SHEET 2/2 版本/Rev B</p>
<p>品名 (PART NAME) XA 2.50mm 90° Wafer Connector Series</p>	<p>料号 (PART NO) W2509RD-NP</p>
<p>状态码 C</p>	