

RoHS

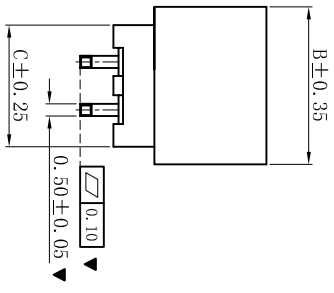

2x02P

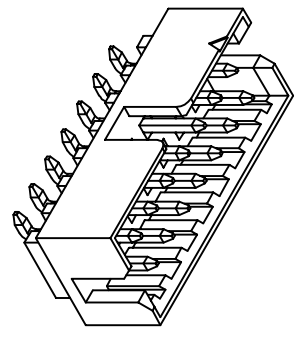
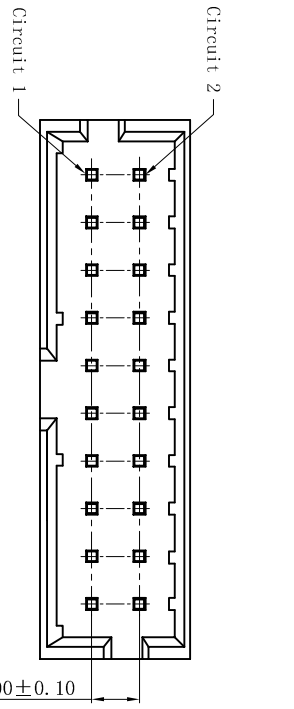
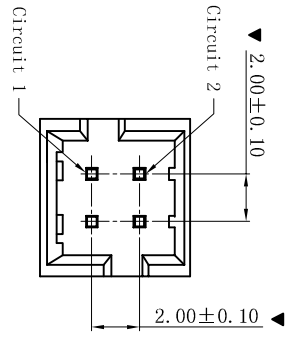
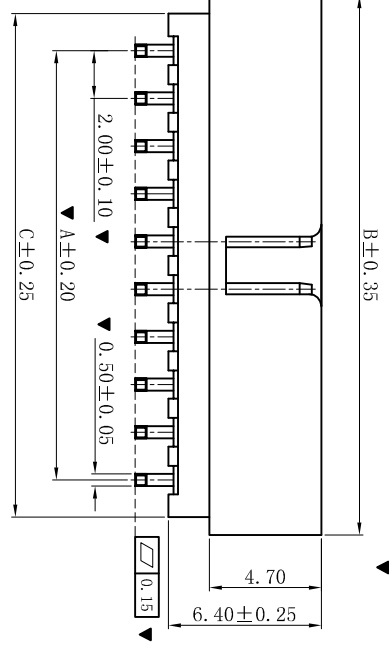

2x03P~2x25P

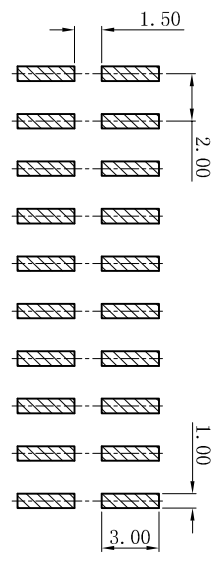
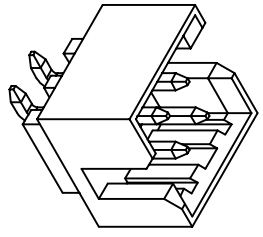
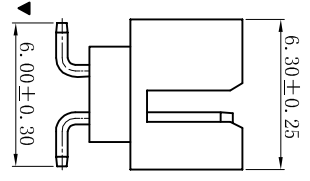

P.C.B LAYOUT

- ### ■ SPECIFICATIONS
- Voltage rating: 250V AC, DC
 - Current rating: 3A, AC, DC
 - Withstanding Voltage: 800V AC/minute
 - Insulation resistance: 1000MΩ min
 - Temperature range: -25° C~+85° C
 - Contact resistance: 20mΩ max
- ### ■ WAFER
- Part No.: WJLT2010SV-2xNP-B
 - Poles : 04-50P
 - Housing Material: PA6T UL94V-0
 - Pin Material: Brass
 - Contact Area Plating: Gold-flash
 - The Dimension Marked “▼” Must Be Recorded

Poles	Dimension (mm)			Dimension (mm)			
	A	B	C	A	B	C	
2x02	2.00	6.65	5.00	2x14	26.00	30.65	29.00
2x03	4.00	8.65	7.00	2x15	28.00	32.65	31.00
2x04	6.00	10.65	9.00	2x16	30.00	34.65	33.00
2x05	8.00	12.65	11.00	2x17	32.00	36.65	35.00
2x06	10.00	14.65	13.00	2x18	34.00	38.65	37.00
2x07	12.00	16.65	15.00	2x19	36.00	40.65	39.00
2x08	14.00	18.65	17.00	2x20	38.00	42.65	41.00
2x09	16.00	20.65	19.00	2x21	40.00	44.65	43.00
2x10	18.00	22.65	21.00	2x22	42.00	46.65	45.00
2x11	20.00	24.65	23.00	2x23	44.00	48.65	47.00
2x12	22.00	26.65	25.00	2x24	46.00	50.65	49.00
2x13	24.00	28.65	27.00	2x25	48.00	52.65	51.00

XYDZ® 东莞市祥运连接器有限公司
 Dongguan XiangYun Connectors CO., Ltd

D	更新图画	2019-06-03	陈雄军	更新图画
C	修订版本	2015-11-04	陈雄军	修订版本
B	变更图宽格式内容	2013-12-27	陈雄军	变更图宽格式内容
A	新版本	2011-05-24	陈雄军	新版本
H	说明	日期	承认	说明
1	REV.	DESCRIPTION	APPRO.	DESCRIPTION

一般公差		0±0.30	投影法 Projection	品名 (PART NAME)	2.00mm SWT 180° 筒牛
GENERAL TOLERANCE:		.00±0.25			
角度: ±1°		.000±0.05	单位 Unit	料号 (PART NO)	WJLT2010SV-2xNP-B
ANGLE: ±1°		MM			
绘图/DR		陈雄军	比例/Scale	状态码	C
审核/CHECK		胡进			
批准/APPRO		2019-06-03	大小/Size		
日期/DATE			页码/Sheet		
			版本/Rev		