

ROHS

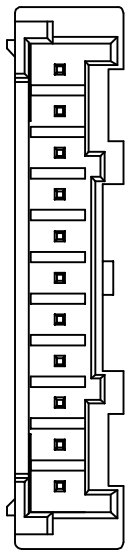
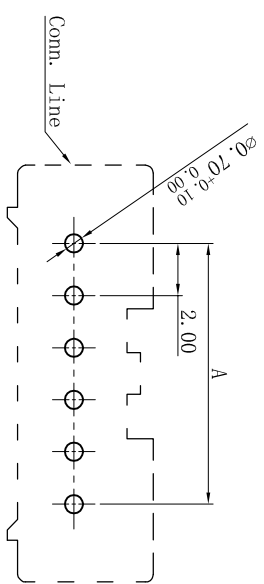
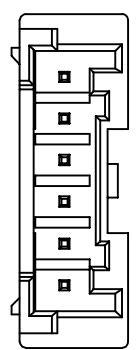
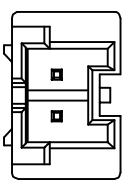
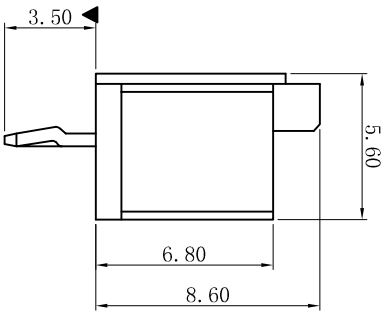
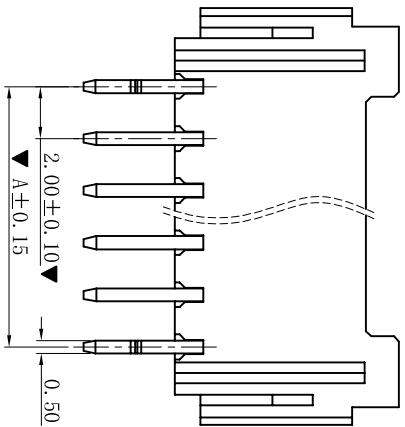
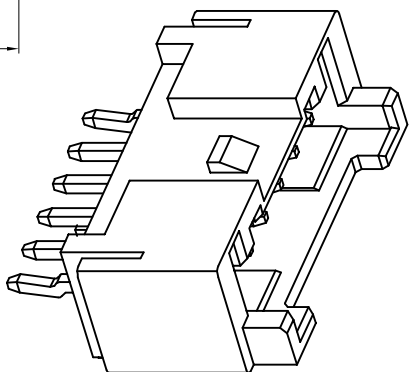
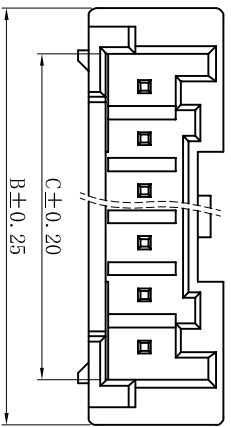

- SPECIFICATIONS
- Voltage rating: 250V AC, DC
  - Current rating: 3A, AC, DC
  - Withstanding Voltage: 800V AC/minute
  - Insulation resistance: 1000MΩ min
  - Temperature range: -25° C ~ +85° C
  - Contact resistance: 20mΩ max
- WAFER
- Part No.: W2013V-NP
  - Poles : 02-16P
  - Housing Material: PA9T UL94V-0 Black.
  - Pin Material: Brass
  - Contact Area Plating: Tin-Plated
  - The Dimension Marked “▲” Must Be Recorded

Poles	Dimension (mm)		
	A	B	C
02	2.00	8.00	4.50
03	4.00	10.00	6.50
04	6.00	12.00	8.50
05	8.00	14.00	10.50
06	10.00	16.00	12.50
07	12.00	18.00	14.50
08	14.00	20.00	16.50
09	16.00	22.00	18.50
10	18.00	24.00	20.50
11	20.00	26.00	22.50
12	22.00	28.00	24.50
13	24.00	30.00	26.50
14	26.00	32.00	28.50
15	28.00	34.00	30.50
16	30.00	36.00	32.50

一般公差 GENERAL TOLERANCE:	±0.30 .0±0.25 .00±0.20 .000±0.05
角度/DR	09P~16P SCALE 1:0.8

**XYDZ® 东莞市祥运连接器有限公司**  
Dongguan XiangYun Connectors CO., Ltd

D	更新图面	2019-06-03	陈雄军	陈雄军	更新图面	2019-06-03	陈雄军	陈雄军	更新图面
C	修订版本	2016-03-09	陈雄军	陈雄军	修订版本	2016-03-09	陈雄军	陈雄军	修订版本
B	变更图宽格式内容	2014-12-25	陈雄军	陈雄军	变更图宽格式内容	2014-12-25	陈雄军	陈雄军	变更图宽格式内容
A	新版本	2012-06-20	陈雄军	陈雄军	新版本	2012-06-20	陈雄军	陈雄军	新版本
H	说明	日期	承认	说明	日期	承认	说明	日期	承认
H	版次	REV.	DESCRIPTION	版次	REV.	DESCRIPTION	版次	REV.	DESCRIPTION

投影法 Projection	第一角	品名 (PART NAME)	PA2.00mm 180° Wafer
单位 Unit	MM	料号 (PART NO)	W2013V-NP
比例/Scale	1:1	状态码	C
大小/Size	A4		
页码/SHEET	1/1		
版本/Rev	D		